



B410P



User Manual



Digium, Inc.
445 Jan Davis Drive
Huntsville, AL 35806
United States
Main Number: 1.256.428.6000
Tech Support: 1.256.428.6161
U.S. Toll Free: 1.877.344.4861
Sales: 1.256.428.6262
www.digium.com
www.asterisk.org
www.asterisknow.org

© Digium, Inc. 2013
All rights reserved.

No part of this publication may be copied, distributed, transmitted, transcribed, stored in a retrieval system, or translated into any human or computer language without the prior written permission of Digium, Inc.

Digium, Inc. has made every effort to ensure that the instructions contained in this document are adequate and error free. The manufacturer will, if necessary, explain issues which may not be covered by this documentation. The manufacturer's liability for any errors in the documents is limited to the correction of errors and the aforementioned advisory services.

This document has been prepared for use by professional and properly trained personnel, and the customer assumes full responsibility when using it.

Adobe and Acrobat are registered trademarks, and Acrobat Reader is a trademark of Adobe Systems Incorporated.

Asterisk, Digium, Switchvox, and AsteriskNOW are registered trademarks and Asterisk Business Edition, AsteriskGUI, and Asterisk Appliance are trademarks of Digium, Inc.

Any other trademarks mentioned in the document are the property of their respective owners.

Compliance Information

Compliance information for this product is available at <http://www.digium.com/ccs-compliance>.

Introduction to B410P Documentation

This manual contains product information for the B410P card. Be sure to refer to any supplementary documents or release notes that were shipped with your equipment. The manual is organized in the following manner:

Chapter/ Appendix	Title	Description
1	Overview	Identifies the features of your card. This chapter covers applications and uses of the B410P in the real world.
2	Card Installation	Provides instructions for installing the card in your PC, acquiring correct drivers, and checking device compatibility.
3	Configuration	Provides steps for configuring and verifying the install of your B410P was successful.
4	Troubleshooting	Explains resolutions to common problems and frequently asked questions pertaining to card installation and usage.
A	Pin Assignments	Lists the connectors and pin assignments.
B	Specifications	Details card specifications.
C	Glossary and Acronyms	Defines terms related to this product.

Symbol Definitions



Caution statements indicate a condition where damage to the unit or its configuration could occur if operational procedures are not followed. To reduce the risk of damage or injury, follow all steps or procedures as instructed.



The ESD symbol indicates electrostatic sensitive devices. Observe precautions for handling devices. Wear a properly grounded electrostatic discharge (ESD) wrist strap while handling the device.



The Electrical Hazard Symbol indicates a possibility of electrical shock when operating this unit in certain situations. To reduce the risk of damage or injury, follow all steps or procedures as instructed.

Important Safety Instructions

User Cautions



Servicing.

Do not attempt to service this card unless specifically instructed to do so. Do not attempt to remove the card from your equipment while power is present. Refer servicing to qualified service personnel.



Water and Moisture.

Do not spill liquids on this unit. Do not operate this equipment in a wet environment.



Heat.

Do not operate or store this product near heat sources such as radiators, air ducts, areas subject to direct, intense sunlight, or other products that produce heat.



Static Electricity.

To reduce the risk of damaging the unit or your equipment, do not attempt to open the enclosure or gain access to areas where you are not instructed to do so. Refer servicing to qualified service personnel.

Save these instructions for future reference.

TABLE OF CONTENTS

Chapter 1

Overview	11
What is Asterisk®?	12
Asterisk as a Switch (PBX)	12
Asterisk as a Gateway	12
Asterisk in the Call Center	13
Asterisk in the Network	13
Asterisk Everywhere	13

Chapter 2

Card Installation	14
Unpacking the Card	15
Inspecting the Shipment	15
Identifying Communication Ports	16
Selecting NT or TE Mode	18
Terminating the NT Mode Line	19
Installing the Hardware	20
Software Installation	22
Installing Asterisk	26

Chapter 3

Configuration	28
Driver Configuration	29
Testing Your Configuration	35

Configure the interface to Asterisk	37
Enabling Echo Cancellation	40
.....	40
Test Configuration	40
Chapter 4	
Troubleshooting	43
Appendix A	
Pin Assignments	48
Appendix B	
Specifications	49
Appendix C	
Glossary and Acronyms	51

Figure 1: Sample Card Application11
Figure 2: B410P Card17
Figure 3: NT and TE Mode Jumper Positions18
Figure 4: NT Termination Switches19
Figure 5: Jumpers Reserved for Future Use20
Figure 6: Insert the Card21
Figure 7: Example dmesg Output35

Table A-1: RJ45 ISDN BRI S/T Port Connector48
Table B-2: Maximum Power Consumption50

Chapter 1

Overview

The Digium B410P is a four port BRI line termination card, compatible with Euro-ISDN. It is capable of serving as Terminal Equipment (TE) or as a Network Termination (NT) device. When configured as an NT device, it is the source of BRI lines as shown in Figure 1. The B410P can also improve voice quality in environments where software echo cancellation is not sufficient with hardware echo cancellation on board.

Note: The B410P does not support North American BRI.

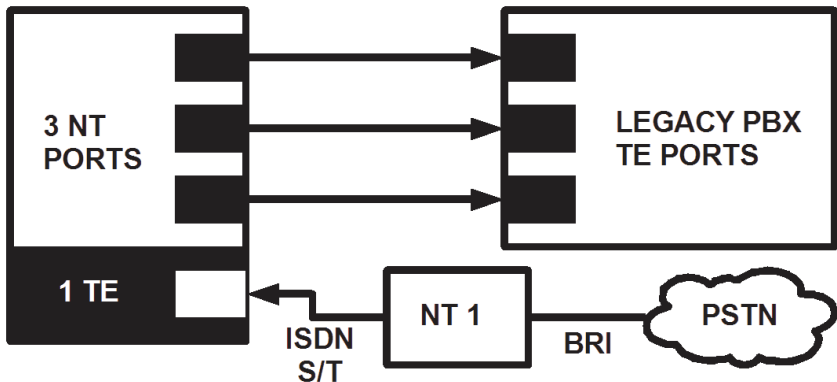

Figure 1: Sample Card Application

What is Asterisk®?

Asterisk is the world's leading open source telephony engine and tool kit. Offering flexibility unheard of in the world of proprietary communications, Asterisk empowers developers and integrators to create advanced communication solutions...for free. Asterisk is released as open source under the GNU General Public License (GPL), and it is available for download free of charge. Asterisk is the most popular open source software available, with the Asterisk Community being the top influencer in VoIP.

Asterisk as a Switch (PBX)

Asterisk can be configured as the core of an IP or hybrid PBX, switching calls, managing routes, enabling features, and connecting callers with the outside world over IP, analog (POTS), and digital (T1/E1) connections.

Asterisk runs on a wide variety of operating systems including Linux, Mac OS X, OpenBSD, FreeBSD, and Sun Solaris. It provides all of the features you would expect from a PBX including many advanced features that are often associated with high end (and high cost) proprietary PBXs. Asterisk's architecture is designed for maximum flexibility and supports Voice over IP in many protocols, and can interoperate with almost all standards-based telephony equipment using relatively inexpensive hardware.

Asterisk as a Gateway

It can also be built out as the heart of a media gateway, bridging the legacy PSTN to the expanding world of IP telephony. Asterisk's modular architecture allows it to convert between a wide range of communications protocols and media codecs.

Asterisk as a Feature/Media Server

Need an IVR? Asterisk's got you covered. How about a conference bridge? Yep. It's in there. What about an automated attendant? Asterisk does that too. How about a replacement for your aging legacy voicemail system? Can do. Unified messaging? No problem. Need a telephony interface for your web site? Ok.

Asterisk in the Call Center

Asterisk has been adopted by call centers around the world based on its flexibility. Call center and contact center developers have built complete ACD systems based on Asterisk. Asterisk has also added new life to existing call center solutions by adding remote IP agent capabilities, advanced skills-based routing, predictive and bulk dialing, and more.

Asterisk in the Network

Internet Telephony Service Providers (ITSPs), competitive local exchange carriers (CLECS) and even first-tier incumbents have discovered the power of open source communications with Asterisk. Feature servers, hosted services clusters, voicemail systems, pre-paid calling solutions, all based on Asterisk have helped reduce costs and enabled flexibility.

Asterisk Everywhere

Asterisk has become the basis for thousands of communications solutions. If you need to communicate, Asterisk is your answer. For more information on Asterisk, visit <http://www.asterisk.org> or <http://www.digium.com>.

Chapter 2

Card Installation

This chapter provides the following information:

- **Unpacking the Card** on page 15
- **Inspecting the Shipment** on page 15
- **Identifying Communication Ports** on page 16
- **Selecting NT or TE Mode** on page 18
- **Terminating the NT Mode Line** on page 19
- **Installing the Hardware** on page 20
- **Software Installation** on page 22
- **Installing Asterisk** on page 26

Unpacking the Card

When you unpack your card, carefully inspect it for any damage that may have occurred in shipment. If damage is suspected, file a claim with the carrier and contact the reseller from which the card was purchased, or contact Digium Technical Support (+1.256.428.6161). Keep the original shipping container to use for future shipment or proof of damage during shipment.

Note: Only qualified service personnel should install the card. Users should not attempt to perform this function themselves.

Inspecting the Shipment

The following items are included in shipment of a B410P:

- B410P card

Identifying Communication Ports

The B410P card has four RJ45 ports and four status LEDs. The ports are used for connecting Basic Rate ISDN (BRI) lines. Each port can be configured as either TE or NT operation. The ports are numbered in sequence from one to four. The top port is Port 1 and the bottom port is Port 4. See Figure 2 on page 17 for appropriate identification of these ports.

Note: It is important to identify the type of BRI line each port is configured for, either TE or NT. You will need this information during the Asterisk configuration.

Each RJ45 port is accompanied by a status LED. The status LEDs can indicate the following:

- Green - Card is in-sync with the far end.
- Red - Card is not seeing far end, circuit is not up, or cable is bad.

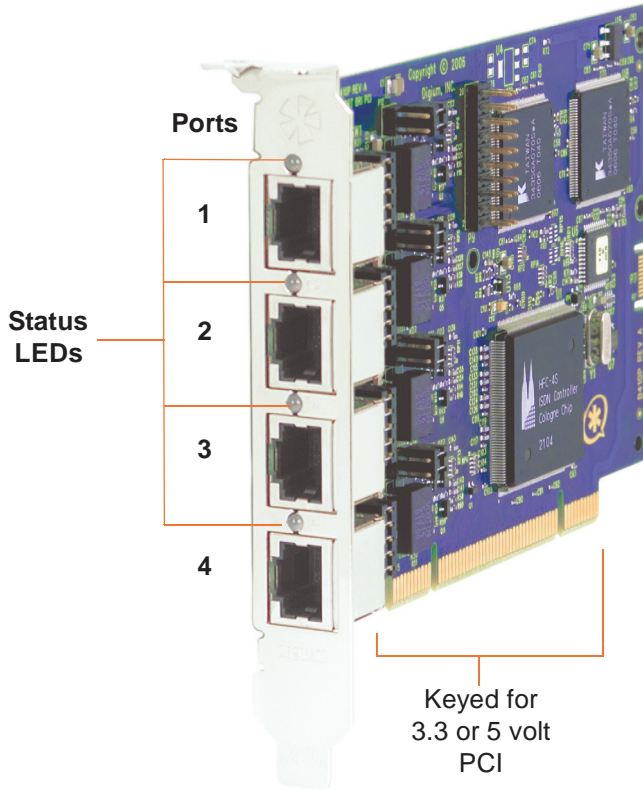

Figure 2: B410P Card

Selecting NT or TE Mode

There is a 5-position jumper on the board for each port to select between NT and TE mode. This must be set before installing the card. Each of the four ports can be set for TE or NT mode independently. This eliminates the need to use a crossover cable. Place the jumper on the left side of the connector for NT mode, or place it on the right side for TE mode as shown in Figure 3. The default setting is TE mode. Notice in Figure 5 on page 20 there is an additional set of jumpers which is reserved for future use. These jumpers are not to be used at this time.



There is a risk of electrical shock due to lightning when this device is utilized in TE mode. Take safety precautions when using the card in this manner.

Note: Be careful when changing the jumper position.

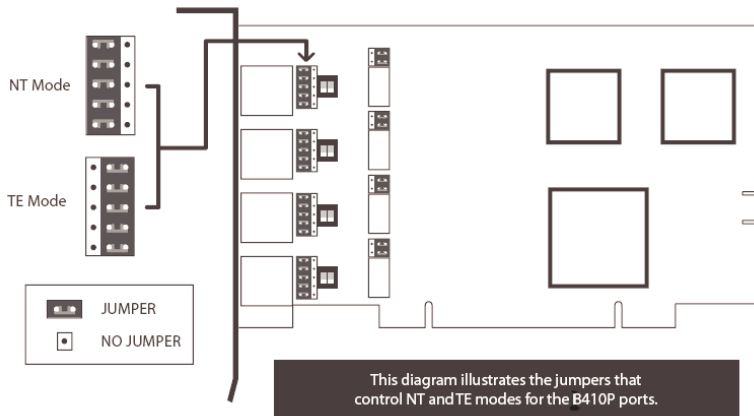

Figure 3: NT and TE Mode Jumper Positions

Terminating the NT Mode Line

There are DIP switches for each port used to add a 100 ohm termination when the B410P is in NT mode. This switch should only be turned on in those instances where a BRI is daisy-chained and terminated on the B410P in NT mode. See Figure 4 for a detailed illustration of this setting. This switch must not be turned on in TE mode. The default setting is Off.



Caution.

Only qualified service personnel should continue with hardware installation and configuration of the B410P card. Users should not attempt to perform these functions themselves.

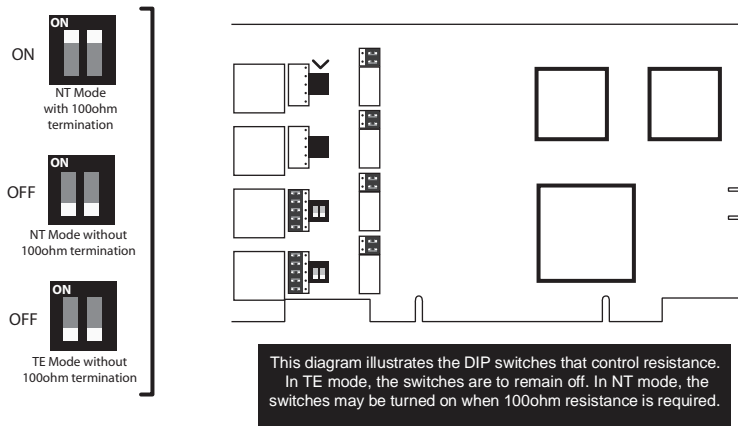

Figure 4: NT Termination Switches

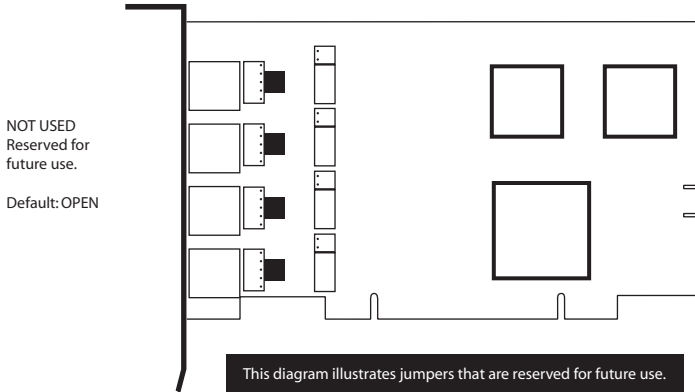

Figure 5: Jumpers Reserved for Future Use

Installing the Hardware

1. Now that you are acquainted with your card, power down your computer and unplug it from its power source.
2. Attach a static strap to your wrist and open the case.
3. Check the NT or TE mode jumper setting to ensure it matches your equipment configuration.
4. Remove the bracket place holder and insert the card into a PCI slot. See Figure 6.

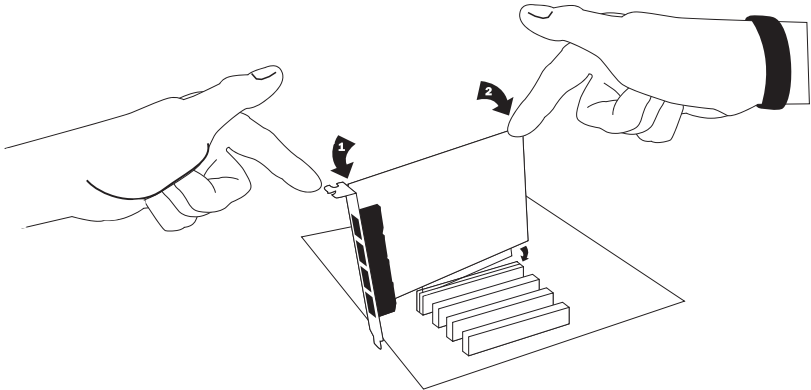

Figure 6: Insert the Card

5. Replace the cover to your computer.
6. Plug all ISDN equipment cables into the RJ45 ports as needed.
7. Power on your computer.

Software Installation

Digium hardware requires drivers and libraries that are not integrated with the Linux kernel. Digium hardware is only supported under Linux. Digium recommends CentOS, Debian, Red Hat, and Ubuntu distributions of Linux. However, many other distributions are supported by Digium Technical Support.

Digium's software, including drivers and application software, may be obtained from Digium's download server at:

<http://downloads.digium.com>

For an introduction to Asterisk, Digium's telephony software, including additional information on its configuration, setup, and features, please refer to:

<http://www.asterisk.org>

For the latest information on setting up and configuring DAHDI drivers for your Digium hardware product, please refer to the latest release of this manual which is available from the product-specific documentation section at:

<http://www.digium.com>

To install your B410P card, you will need:

- Full Linux kernel 2.6.15 (or later) source code.
- Development libraries and headers for ncurses
- Development libraries and headers for zlib and openssl
- Development libraries and headers for newt
- GCC and standard software build tools

It is recommended that you use the most recent version of the Asterisk, DAHDI, and libpri software for the best results. If you have previously installed any of these, Digium recommends that you upgrade to the latest “-current” version of each.

Note: The new method for configuring the B410P requires Asterisk 1.6 (or later), DAHDI, and libpri 1.4.4 (or later). If you wish to use the old, unsupported method which works with Asterisk 1.4, you will need to follow the installation procedure for mISDN and mISDNuser which is available at <http://www.misdn.org/>. The configuration procedure for mISDN is listed in Chapter 3—“Configuration”. Please be aware that Digium does not provide support for mISDN.

1. After the machine has booted to Linux, log in and execute the following command to list the devices detected by the PCI bus:

```
# lspci -n
```

Confirm that the output from **lspci** lists a device with Digium’s PCI vendor ID which is “d161”. The screen output should be similar to the following:

```
0000:01:0e.0 ISDN controller: Unknown device
d161:b410 (rev 01)
```

Note: The output from **lspci** may or may not state “Unknown device”. If it does, this does not indicate a problem.

The Digium B410P card identifier should be listed. If a matching card identifier is not listed, then your machine is not PCI 2.2 (or higher), and the card will not work with your motherboard.

2. Download the latest version of libpri. Substitute the version of libpri for the X.X in the command line below. libpri is available for download from:

<http://downloads.asterisk.org/pub/telephony/libpri>

```
# wget http://downloads.asterisk.org/pub/telephony/
libpri/libpri-X.X-current.tar.gz
```

Note: There is no correlation between the versioning of libpri and Asterisk. The libpri 1.4 branch will function with the Asterisk 1.6 and 1.8 branches.

3. Expand the downloaded file, compile its contents, and install the libraries. Substitute the version of libpri for the X.X and X.X.X.X in

the command lines below.

```
# tar -zxvf libpri-X.X-current.tar.gz
# cd libpri-X.X.X.X/
# make
# make install
```

4. Download the latest DAHDI drivers with tools. DAHDI is available for download from:

<http://downloads.digium.com/pub/telephony/dahdi-linux-complete>

```
# wget http://downloads.digium.com/pub/telephony/
dahdi-linux-complete/dahdi-linux-complete-
current.tar.gz
```

5. Expand the downloaded file, compile its contents, and install the drivers and tools. Substitute the version of DAHDI for the X.X.X in the command lines below.

```
# tar -zxvf dahdi-linux-complete-current.tar.gz
# cd dahdi-linux-complete-X.X.X+X.X.X
# make
# make install
# make config
```

Note: Executing ‘make config’ will install an init script and symlinks which will allow you to start and stop DAHDI as a service.

Installing Asterisk

If you wish to use Asterisk with your new hardware, you can follow the instructions below.

Note: The new method for configuring the B410P requires Asterisk 1.6 (or later), DAHDI, and libpri 1.4.4 (or later). If you wish to use the old, unsupported method which works with Asterisk 1.4, you will need to follow the installation procedure for mISDN and mISDNuser which is available at <http://www.misdn.org/>. The configuration procedure for mISDN is listed in Chapter 3—“Configuration”. Please be aware that Digium does not provide support for mISDN.

1. Download the latest release version of Asterisk. Substitute the version of Asterisk for the X.X in the command below. Asterisk is available for download from:

<http://downloads.digium.com/pub/telephony/asterisk>

```
# wget http://downloads.digium.com/pub/telephony/  
asterisk/asterisk-X.X-current.tar.gz
```

2. Expand the downloaded file, compile its contents, and install the application. Substitute the version of Asterisk for the the X.X and X.X.X in the command lines below.

```
# tar -zxvf asterisk-X.X-current.tar.gz  
# cd asterisk-X.X.X/  
# ./configure  
# make menuselect  
# make
```

```
# make install
```

3. If this is the first Asterisk installation on this system, you should install the sample configuration files. To do this, run:

```
# make samples
```

Note: Running this command will overwrite, after making a backup copy, any older Asterisk configuration files that you have in the `/etc/asterisk` directory.

If your installation has failed, it may be because you are missing one or more of the build dependencies, the kernel headers, or the development tools. Please contact your reseller where the card was purchased, or call Digium Technical Support (+1.256.428.6161) for assistance.

Complete instructions for installing Asterisk are available at www.asterisk.org.

Chapter 3

Configuration

The B410P card should be installed and ready to configure. This chapter will provide steps for configuring the card and verifying its setup. The sample configurations are provided to assist you in familiarizing yourself with the flexibility of editing the configuration files to meet your specific needs. The list of possible configurations is too expansive to cover in this user manual.

Most sections in this chapter include two sub-sections. The first sub-section uses the new method for configuring the B410P with DAHDI. The second sub-section uses the old, unsupported method for configuring the B410P with mISDN. Please be aware that Digium does not provide support for mISDN.

Driver Configuration

Using DAHDI:

1. Begin by opening the **system.conf** file from the **/etc/dahdi** directory.
2. Specify the two letter country code for your loadzone and defaultzone. This will preload tone zone data and specify a default tone zone for your interfaces.

The following is a typical setup for a telco in Spain:

```
loadzone = es
defaultzone = es
```

3. Configure the Span Map.

For each BRI line you are using, you will need to define a span. The Span Map includes defining the span number, timing, line build out, framing, and coding. Configuration details for each of these items is explained in this section.

```
span => <Number>,<Timing>,<Line Build
Out>,<Framing>,<Coding>[,Yellow]
```

Number:

This is the port the BRI line is plugged into. Port 1 being the furthest span from the PCI bus. The port numbers are noted on the PCI bracket.

Timing:

This determines how timing is handled by the card.

- 0 - Card provides its own timing
- 1 - Receives timing from remote end
- 2 - Receives secondary backup timing from remote end
- 3 - Receives tertiary backup timing from remote end
- 4 - Receives quaternary backup timing from remote end

Only one span can be defined to take timing, and it defines timing for the rest of the card's spans.

Line Build Out:

For most setups, the line build out is 0.

0: 0 db (CSU) / 0-133 feet (DSX-1)

1: 133-266 feet (DSX-1)

2: 266-399 feet (DSX-1)

3: 399-533 feet (DSX-1)

4: 533-655 feet (DSX-1)

5: -7.5db (CSU)

6: -15db (CSU)

7: -22.5db (CSU)

Framing:

BRI utilizes CCS framing.

Coding:

BRI utilizes AMI coding.

Yellow:

The optional yellow flag can be added at the end for transmitting a yellow alarm when no channels are open.

The following is a typical setup for a BRI span:

```
span => 1,0,0,ccs,ami
```

4. Specify the channel definitions. The format is:

```
<device> = <channel list>
```

A list of valid devices are specified in the sample system.conf file.

The following is a typical setup for BRI:

```
bchan = 1,2  
hardhdlc = 3
```

The bchan device specifies the bearer channels (B channels). The hardhdlc device specifies the delta channel (D channel).

Note: Unlike Digium's Digital E1 cards, the device for the delta channel must be specified as hardhdlc instead of dchan. The B410P will not function properly if dchan is specified.

The following is a typical **system.conf** setup for BRI:

```
loadzone = es
defaultzone = es

span = 1,1,0,ccs,ami
bchan = 1,2
hardhdlc = 3

span = 2,0,0,ccs,ami
bchan = 4,5
hardhdlc = 6

span = 3,0,0,ccs,ami
bchan = 7,8
hardhdlc = 9

span = 4,0,0,ccs,ami
bchan = 10,11
hardhdlc = 12
```

Using mISDN:

1. Execute the following:

```
# /etc/init.d/misdn-init config
```

2. Edit the following appropriately (it is self documented):

```
# /etc/misdn-init.conf
```

Testing Your Configuration

Using DAHDI:

1. Load DAHDI drivers into the kernel using the **modprobe** utility. The appropriate driver for the B410P cards is **wcb4xxp**. Execute the following commands:

```
# modprobe wcb4xxp
# dahdi_cfg -vv
# dmesg
```

```
dahdi: Telephony Interface Registered on major 196
dahdi: Version: 2.1.0.4
wcb4xxp 0000:00:06.0: probe called for b4xx...
PCI: Enabling device 0000:00:06.0 (0000 -> 0003)
ACPI: PCI Interrupt 0000:00:06.0[A] -> GSI 17 (level, low) -> IRQ 217
wcb4xxp 0000:00:06.0: Identified Wildcard B410P (controller rev 1) at 00012c20, IRQ 217
wcb4xxp 0000:00:06.0: VPM 0/1 init: chip ver 33
wcb4xxp 0000:00:06.0: VPM 1/1 init: chip ver 33
wcb4xxp 0000:00:06.0: Hardware echo cancellation enabled.
wcb4xxp 0000:00:06.0: Port 1: TE mode
wcb4xxp 0000:00:06.0: Port 2: TE mode
wcb4xxp 0000:00:06.0: Port 3: TE mode
wcb4xxp 0000:00:06.0: Port 4: TE mode
wcb4xxp 0000:00:06.0: Did not do the highestorder stuff
dahdi: Registered tone zone 6 (Spain)
wcb4xxp 0000:00:06.0: new card sync source: port 3
```

Figure 7: Example dmesg Output

Note: Output as shown above may vary slightly.

2. Run **dahdi_tool** from the command line and see if the span turns green for each span you have connected.

```
# dahdi_tool
```

Using mISDN:

1. Load it by executing this command:

```
# /etc/init.d/misdn-init start
```

2. Make sure the driver successfully loaded:

```
# lsmod | grep hfcmulti
```

3. The **hfcmulti** driver should be listed.

Configure the interface to Asterisk

Using DAHDI:

You will need to modify the **chan_dahdi.conf** file which is located in the `/etc/asterisk` directory in order to configure the essential features of your card. This file is the configuration layer between DAHDI and Asterisk.

Echo Cancellation:

Echo Cancellation is enabled in `chan_dahdi.conf` by preceding the channel variable with a variable called `echocancel`; for example:

```
echocancel = yes
channel => 1,2,4,5,7,8,10,11
```

Echo cancellation is explicitly disabled by setting:

```
echocancel = no
```

Note: Digium does not recommend that users set echo cancellation to "no."

Signalling:

Set the signalling option.

Signalling	Option	Notes
CPE side using Point-to-Point	bri_cpe	
CPE side using Point-to-Multipoint	bri_cpe_ptmp	
NET side using Point-to-Point	bri_net	
NET side using Point-to-Multipoint	bri_net_ptmp	Requires libpri 1.4.11 (or later), Asterisk 1.8 (or later), and an externally powered ISDN phone. See Asterisk 1.8's sample chan_dahdi.conf for specific parameters and features.

Add these lines to the sample **chan_dahdi.conf** file.

```
signalling = bri_cpe
switchtype = euroisdn
group = 1
context = incoming
echocancel = yes
channel => 1,2,4,5,7,8,10,11
```

Using mISDN:

Configure the interface to Asterisk by editing the following:

```
/etc/asterisk/misdn.conf
```

The **misdn.conf** file contains detailed comments documenting the options that are available and their meaning. It is recommended that you carefully review the options to set them appropriately. An example **misdn.conf** is provided below.

Be sure to set the MSNS properly (MSNS are like DID's). In order to accept all incoming DID's, set **msns=***. Also, don't forget to specify a **ports** setting as well in your specified category within **misdn.conf**. Hardware echo cancellation does not require configuration for echotraining. Be sure to set **echotraining=no** in your **misdn.conf**.

misdn.conf:

```
context=default
echocancel=yes
echotraining=no

[myoutsidelines]
msns=*
ports=1,2,3,4
context=default
```

Enabling Echo Cancellation

The B410P card is enhanced with built-in echo cancellation. It improves voice quality in environments where software echo cancellation is not sufficient. The B410P reduces CPU overhead required for software echo cancellation, freeing resources for other processes such as codec translation. The B410P provides 64ms of echo cancellation simultaneously on all eight B-channels. Echo cancellation is enabled by setting **echocancel=yes** in `chan_dahdi.conf` (if using mISDN, set in **misdn.conf** instead).

Test Configuration

Verify the Asterisk interface is properly configured by placing a phone call. First, you will need to start Asterisk, and then connect to the Asterisk

CLI. In order to call out over a specific port, the **Dial()** command is formatted as follows:

```
# asterisk
# asterisk -vvvr
```

Using DAHDI:

```
Dial (DAHDI/1/${EXTEN})
```

Using mISDN:

```
Dial (misdn/1/${EXTEN})
```

If you would like to dial out over a group (groups are defined by the categories, or bracket-enclosed titles within `misdn.conf`), simply use the group name appended to **g:** like so:

Using DAHDI:

```
Dial (DAHDI/g1/${EXTEN})
```

Using mISDN:

Dial (misdn/g:myoutsidelines/{EXTEN})

Note: More information can be obtained by contacting Digium Technical Support (+1.256.428.6161) or visiting the website at www.digium.com. You may also contact your distributor or reseller from which the card was purchased for assistance. Please be aware that Digium does not provide support for mISDN.

Chapter 4

Troubleshooting

This chapter provides frequently asked questions as identified from Digium Technical Support and possible resolutions. Multiple resources are available to obtain more information about Asterisk and Digium products. These resources are listed on page 47.

What do the Status LED colors indicate?

- Green - Card is in-sync with the far end.
- Red - Card is not seeing far end, circuit is not up, or cable is bad.

What type of cable do I need?

In all cases, you can use a straight-through, standard RJ-45 Ethernet cable going from the NT unit to the B410P. When you put the card in NT mode with the correct jumpers, the pins will automatically swap as seen in the following example.

Pin 3 <-> Pin 4

Pin 5 <-> Pin 6

Which BRI protocol is used on the B410P?

The B410P supports the ETSI standard using CPE-PTP (Point-to-Point), CPE-PTMP (Point-to-Multipoint), NET-PTP (Point-to-Point), and NET-PTMP (Point-to-Multipoint).

Will the B410P power an ISDN phone?

No, the B410P will not provide power to an ISDN phone. An externally powered ISDN phone must be used when configured for NET-PTMP.

I can't receive DID calls even though I have it enabled in extensions.conf.

Make sure the ports are set to the correct jumper setting and that the **chan_dahdi.conf** (if using mISDN, then check **misdn-init.conf**) reflects this setting. Phone calls will not work without this being correct.

How can I enable more features?

To view all of the options available to add to your dial plan, type the following commands from within Asterisk:

```
*CLI> core show applications
*CLI> core show functions
```

Digium also offers services to help configure and add features you might need. Contact Digium Technical Support (+1.256.428.6161) for more information.

Common Fixes for all cards

1. Check to see if the X Window System (e.g. X.Org Server) is running by entering the following:

```
# ps aux | grep X
```

If the X Window System is running, stop the application since it may cause a conflict with Asterisk.

2. Check to see if your PATA IDE hard drives are running with DMA levels set. Advance user can perform an **hdparm** on your hard drive interface.



Use hdparm with caution as the man page states that hard drive corruption can occur when using incorrect settings. Please review the man page for hdparm and make sure you understand the risks before using this tool.

Check the current mode using this command:

```
hdparm -vi /dev/[IDE Device]
```

Use this command to set the drives into UDMA2 mode:

```
hdparm -d 1 -X udma2 -c 3 /dev/[IDE Device]
```

If you are still having problems, contact your reseller from which the card was purchased, or Digium Technical Support (+1.256.428.6161).

Where can I find answers to additional questions?

There are several places to inquire for more information about Asterisk Digium products:

1. Digium Technical Support (+1.256.428.6161), or Toll Free in the U.S. (1.877.344.4861), is available 7am-8pm Central Time (GMT -6), Monday - Friday.
2. Asterisk users mailing list (asterisk.org/lists.digium.com).
3. IRC channel **#asterisk** on (irc.freenode.net).

Subscription Services Program

Digium is dedicated to supporting your Asterisk system by offering full technical support through our Subscription Services Program. Through this program, you can be at ease knowing that your business will always have access to the Asterisk experts. Pricing on Subscription Services may be obtained from your nearest reseller or you may call Digium Sales for referral to your nearest reseller at +1.256.428.6000 or e-mail sales@digium.com.

Appendix A

Pin Assignments

All four ports on the B410P bracket are 8-pin RJ45 ISDN BRI S/T ports. The pin assignments are identified in Table A-1.

Table A-1: RJ45 ISDN BRI S/T Port Connector

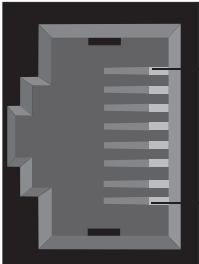
	Pin	TE	NT
 <p>Pin 1</p> <p>Pin 8</p>	1	Unused	Unused
	2	Unused	Unused
	3	Tx+	Rx+
	4	Rx+	Tx+
	5	Rx-	Tx-
	6	Tx-	Rx-
	7	Unused	Unused
	8	Unused	Unused

Appendix B

Specifications

This appendix provides specifications, required environmental conditions, and maximum power consumption for the B410P card.

Physical.

Size: 5.5" × 3.75" × 0.735" (13.97 x 9.53 x 1.86 cm)
PCB size, does not include the PCI bracket

Weight: 3.5 oz (109gm)

Interfaces.

Local Loop Access: ISDN S/T BRI; RJ45

PCI Bus: 3.3V or 5V bus slot, half-length slot minimum size, 33MHz minimum bus speed, compliant with PCI 2.2 or greater.

Environment.

Temperature: 0 to 50° C (32 to 122° F) operation
-20 to 65° C (4 to 149° F) storage

Humidity: 10 to 90% non-condensing

Hardware and Software Requirements.

800-Mhz processor or better

64MB RAM

Available 2.2 PCI Slot (as described previously)

Table B-2: Maximum Power Consumption

Model	Power
B410P 3.3V 5V	2.5 Watts 5.3 Watts

Appendix C

Glossary and Acronyms

ANSI *American National Standards Institute*

An organization which proposes and establishes standards for international communications.

asynchronous

Not synchronized; not timed to an outside clock source. Transmission is controlled by start bits at the beginning and stop bits at the end of each character. Asynchronous communications are often found in internet access and remote office applications.

attenuation

The dissipation of a transmitted signal's power as it travels over a wire.

bandwidth

The capacity to carry traffic. Higher bandwidth indicates the ability to transfer more data in a given time period.

bit

The smallest element of information in a digital system. A bit can be either a zero or a one.

bps *bits per second*

A measurement of transmission speed across a data connection.

broadband

Broadband transmission shares the bandwidth of a particular medium (copper or fiber optic) to integrate multiple signals. The channels take up different frequencies on the cable, integrating voice, data, and video over one line.

channel

A generic term for an individual data stream. Service providers can use multiplexing techniques to transmit multiple channels over a common medium.

Cat5

Category of Performance for wiring and cabling. Cat 5 cabling support applications up to 100 MHz.

Cat5E

Category of Performance for wiring and cabling. Category 5 Enhanced wiring supports signal rates up to 100 MHz but adheres to stricter quality specifications.

CLEC *competitive local exchange carrier*

A term for telephone companies established after the Telecommunications Act of 1996 deregulated the LECs. CLECs compete with ILECs to offer local service. See also *LEC* and *ILEC*.

CO *central office*

The CO houses local switching equipment. All local access lines in a particular geographic area terminate at this facility (which is usually owned and operated by an ILEC).

CPE *customer premises equipment*

Terminal equipment which is connected to the telecommunications network and which resides within the home or office of the customer. This includes telephones, modems, terminals, routers, and television set-top boxes.

DAHDI *Digium Asterisk Hardware Device Interface*

A telephony project dedicated to implementing a reasonable and affordable computer telephony platform into the world marketplace. Also, the collective name for the Digium-provided drivers for Digium telephony interface products.

DS0 *Digital Signal, Level 0*

A voice grade channel of 64 Kbps. The worldwide standard speed for digitizing voice conversation using PCM (Pulse Code Modulation).

DS1 *Digital Signal, Level 1*

1.544 Mbps in North America (T1) and Japan (J1) - up to 24 voice channels (DS0s), 2.048 Mbps in Europe (E1) - up to 32 voice channels (DS0s). DS1/T1/E1 lines are part of the PSTN.

DS3 *Digital Signal, Level 3*

T3 in North America and Japan, E3 in Europe. Up to 672 voice channels (DS0s). DS3/T3/E3 lines are not part of the PSTN

DTMF *Dual Tone Multi-Frequency*

Push-button or touch tone dialing.

E1

The European equivalent of North American T1, transmits data at 2.048 Mbps, up to 32 voice channels (DS0s).

E3

The European equivalent of North American T3, transmits data at 34.368 Mbps, up to 512 voice channels (DS0s). Equivalent to 16 E1 lines.

EMI *Electromagnetic Interference*

Unwanted electrical noise present on a power line

full duplex

Data transmission in two directions simultaneously.

FXO *Foreign Exchange Office*

Receives the ringing voltage from an FXS device. Outside lines are connected to the FXO port on your B410P card.

FXS *Foreign Exchange Station*

Initiates and sends ringing voltage. Phones are connected to the FXS ports on the B410P card.

G.711

A recommendation by the Telecommunication Standardization Sector (ITU-T) for an algorithm designed to transmit and receive mulaw PCM voice and A-law at a digital bit rate of 64 Kbps. This algorithm is used for digital telephone sets on digital PBX.

G.723.1

A recommendation by the Telecommunication Standardization Sector (ITU-T) for an algorithm designed to transmit and receive audio over telephone lines at 6.3 Kbps or 5.3 Kbps.

G.729a

A recommendation by the Telecommunication Standardization Sector (ITU-T) for an algorithm designed to transmit and receive audio over telephone lines at 8 Kbps.

H.323

A recommendation by the Telecommunication Standardization Sector (ITU-T) for multimedia communications over packet-based networks.

IAX *Inter-Asterisk eXchange*

The native VoIP protocol used by Asterisk. It is an IETF standard used to enable VoIP connections between Asterisk servers, and between servers and clients that also use the IAX protocol.

iLBC *internet Low Bitrate Codec*

A free speech codec used for voice over IP. It is designed for narrow band speech with a payload bitrate of 13.33 kbps (frame length = 30ms) and 15.2 kbps (frame length = 20 ms).

ILEC *incumbent local exchange carrier*

The LECs that were the original carriers in the market prior to the entry of competition and therefore have the dominant position in the market.

interface

A point of contact between two systems, networks, or devices.

ISO *International Standards Organization*

LED *light-emitting diode*

Linux

A robust, feature-packed open source operating system based on Unix that remains freely available on the internet. It boasts dependability and offers a wide range of compatibility with hardware and software. Asterisk is supported exclusively on Linux.

loopback

A state in which the transmit signal is reversed back as the receive signal, typically by a far end network element.

MGCP *Media Gateway Control Protocol*

multiplexing

Transmitting multiple signals over a single line or channel. FDM (frequency division multiplexing) and TDM (time division multiplexing) are the two most common methods. FDM separates signals by dividing the data onto different carrier frequencies, and TDM separates signals by interleaving bits one after the other.

MUX *multiplexer*

A device which transmits multiple signals over a single communications line or channel. See multiplexing.

PBX *private branch exchange*

A smaller version of a phone company's large central switching office. Example: Asterisk.

PCI *peripheral component interconnect*

A standard bus used in most computers to connect peripheral devices.

POP *point of presence*

The physical connection point between a network and a telephone network. A POP is usually a network node serving as the equivalent of a CO to a network service provider or an interexchange carrier.

POTS *plain old telephone service*

The public switched telephone network (PSTN) is the network of the world's public circuit-switched telephone networks. Originally a network

of fixed-line analog telephone systems, the PSTN is now almost entirely digital, and now includes mobile as well as fixed telephones.

PPP *point-to-point protocol*

Type of communications link that connects a single device to another single device, such as a remote terminal to a host computer.

PSTN *public switched telephone network*

A communications network which uses telephones to establish connections between two points. Also referred to as the dial network.

QoS *quality of service*

A measure of telephone service, as specified by the Public Service Commission.

RJ11

A six-pin jack typically used for connecting telephones, modems, and fax machines in residential and business settings to PBX or the local telephone CO.

SIP *Session Initiation Protocol*

An IETF standard for setting up sessions between one or more clients. It is currently the leading signaling protocol for Voice over IP, gradually replacing H.323.

T1

A dedicated digital carrier facility which transmits up to 24 voice channels (DS0s) and transmits data at 1.544 Mbps. Commonly used to carry traffic to and from private business networks and ISPs.

T3

A dedicated digital carrier facility which consists of 28 T1 lines and transmits data at 44.736 Mbps. Equivalent to 672 voice channels (DS0s).

TDM *time division multiplexer*

A device that supports simultaneous transmission of multiple data streams into a single high-speed data stream. TDM separates signals by interleaving bits one after the other.

telco

A generic name which refers to the telephone companies throughout the world, including RBOCs, LECs, and PTTs.

tip and ring

The standard termination on the two conductors of a telephone circuit; named after the physical appearance of the contact areas on the jack plug.

twisted pair

Two copper wires commonly used for telephony and data communications. The wires are wrapped loosely around each other to minimize radio frequency interference or interference from other pairs in the same bundle.

V *volts*

VoIP *Voice over IP*

Technology used for transmitting voice traffic over a data network using the Internet Protocol.